

PowerDepot H5B

USER MANUAL

Battery System
51.2V/100Ah

Contents

Statement of Law	1
Revision History	1
Safety Precautions	2
Preface	3
Manual Description	3
Safety Statement	3
Sign explanation	3
1 Introduction	4
Brief Introduction	4
Product Properties	4
Product identity definition	5
2 Product Specification	6
Size and Weight	6
Performance Parameter	6
Interface Definition	6
Battery Management System(BMS)	8
3 Installation and Configuration	10
Preparations for installation	10
Equipment installation	13
4 Use, maintenance and troubleshooting	27
Battery system usage and operation instructions	27
Alarm description and processing	27
Analysis and treatment of common faults	28

Statement of Law

Copyright of this document belongs to Dy Ness Digital Energy Technology Co., LTD. No part of this documentation maybe excerpted, reproduced, translated, annotated or duplicated in any form or by any means without the prior written authorization of Dy Ness Digital Energy Technology Co., LTD. All Rights Reserved. This product complies with the design requirements of environmental protection and personal safety. The storage, use and disposal of the products shall be carried out in accordance with the product manual, relevant contract or relevant laws and regulations. Customer can check the related information on the website of Dy Ness Digital Energy Technology Co., LTD. when the product or technology is updated. Web URL:

<http://www.dy ness.com/>

Please note that the product can be modified without prior notification.

Manual Version: V1.0

Revision History

Revision NO.	Revision Date	Revision Reason
1.0	2023.03.23	First Published

Safety Precautions



WARNING

Please do not put the battery into water or fire, in case of explosion or any other situation that might endanger your life.

Please connect wires properly while installation, do not reverse connect.

To avoid short circuit, please do not connect positive and negative poles with conductor on the same device.

Please avoid any form of damage to battery, especially stab, hit, trample or strike.

Please shut off the power completely when removing the device or reconnecting wires during the daily use or it could cause the danger of electric shock.

Please use dry powder extinguisher to put out the flame when encountering a fire hazard, liquid extinguisher could result in the risk of explosion.

For your safety, please do not arbitrarily dismantle any component in any circumstances. The maintenance must be implemented by authorized technical personnel or our company's technical support. Device breakdown due to unauthorized operation will not be covered under warranty.



CAUTION

The products have been strictly checked before shipment. Please contact us if you find any abnormal phenomena such as device outer case bulging.

In order to ensure safety and normal use of the product, the equipment should be grounded properly before use.

To assure the product normal operation, please make sure parameters among the relevant device are compatible and matched.

Please do not mixed-use batteries from different manufacturers, different types and models, as well as old and new together.

Ambient and storage method could impact the product life span, please comply with the operation environment instruction to ensure device works in proper condition.

For long-term storage, the battery should be recharged once every 6 months, and the amount of electric charge shall exceed 80% of the rated capacity.

Please charge the battery in 18 hours after it's fully discharged or over-discharging protection mode is activated.

Formula of theoretical standby time: $T=C/I$ (T is standby time, C is battery capacity, I is total current of all loads).

The surface of the PowerDepot H5B cabinet is affixed with a torn invalid label. Therefore, before opening the cover to change the DIP switch mode, you need to contact and inform us the product ID. We will record this battery ID and authorize the opening operation to be performed. Except for changing the DIP switch mode, no other operations are allowed. In the next stage, you can log in on our website to apply for operating authorization directly.

Preface

Manual Description

PowerDepot H5B Lithium Iron Phosphate Battery is external battery module which can store the electricity for home use. When you apply the grid or photovoltaic system as your powers supply, the product can collect electricity to charges the battery. When grid or photovoltaic system is power off , the product can supply electricity itself for your home loads.

PowerDepot H5B User manual included the device structure, parameters, basic procedure and method of installation, operation, maintenance.

Safety Statement

Only qualified and trained professionals are qualified to install, operate, maintain the device.

Please comply with local safety regulations and operational rules during installation, operation and maintenance, or it could cause unexpected injury or device damage.

The safety declaration mentioned in the manual are only supplement context for your local safety regulations.

The seller does not undertake any responsibility for device operations or usage of violating general safety requirements and safety standards.

Sign explanation

User should clear the meaning of the caution sign below when configuring or operating PowerDepot H5B series products.



CAUTION

Neglecting the warnings might cause equipment failure.

1 Introduction

Brief Introduction

PowerDepot H5B series is equipped with lithium iron phosphate battery for family use . We base on customer needs and market requirement to develop cutting-edge battery storage technology and offer this high quality product to supply stable electricity for all kind of user's devices. The products have long life span and can be applied in high temperature environment and take less space for installation.

PowerDepot H5B series carries self-developed battery management system. When you apply the grid or photovoltaic system as your powers supply, the products can collect electricity to charges the battery. When grid or photovoltaic system is power off , the products can supply electricity itself for your home loads. Products also can be paralleled to build a multi-module system with more capacity to satisfy the longtime energy storage demand.

Product Properties

PowerDepot H5B series energy storage product's anode materials are lithium iron phosphate, battery cells are managed effectively by BMS with better performance.

The systems features as below:

Comply with European ROHS, Certified SGS, employ non-toxic, non-pollution environment-friendly battery.

Anode materials are lithium iron phosphate (LiFePO₄), high safety performance, longer life span.

Equipped with BMS (battery management system) mode, with protection function like over-discharge, over-charge, over-current, abnormal temperature.

Self-management on charging and discharging, Single core balancing function.

Intelligent design configures integrated inspection module.

Flexible configurations, allow parallel of multi-battery for longer standby time.

Self-ventilation, lower system noise.

Less battery self-discharge, then recharging period can be up to 10 months during the storage.

No memory effect so that battery can be charged and discharged shallowly.

With wide range of temperature for working environment, -20°C ~ +55°C, products' life span and discharging performance are well under high temperature.

Less volume, lighter weight, seal grade up to IP65 embedding design for easier installation and maintenance.

Product identity definition

		RECHARGEABLE LI-ION BATTERY		
Product	PowerDepot H5B			
Nominal Energy	5.12kWh			
Voltage Range	44.8V~57.6V			
Capacity/Voltage	100Ah/51.2V			
Max. Charging Current	75A			
Max. Discharging Current	75A			
Ambient Temperature	-10°C~50°C			
Protection Class	I			
IP Grade	IP65			
DAQIN NEW ENERGY TECH(TAIZHOU)CO.,LTD.		S/N:		

Figure 1-1 Battery Energy Storage System nameplate

Table 1-1 Symbol Definition

	Battery voltage is higher than safe voltage, direct contact may cause electric shock hazard.
	Be careful with your actions and be aware of the dangers.
	Read the user manual before using.
	The scrapped battery cannot be put into the garbage can and must be professionally recycled.
	After the battery life is terminated, the battery can continue to be used after it recycled by the professional recycling organization and do not discard it at will.
	This battery product meets European directive requirements.

2 Product Specification

Size and Weight

Table 2-1 PowerDepot H5B series device model

Specification Model	Nominal Voltage	Nominal Capacity	Dimension (mm)	Weight (kg)	IP Level
PowerDepot H5B	51.2V	100Ah	574*228*600mm	55kg	IP65

Performance Parameter

Table 2-2 PowerDepot H5B performance parameter

Item	PowerDepot H5B
Nominal Voltage(V)	51.2
Work Voltage Range(V)	44.8~57.6
Nominal Capacity(Ah)	100Ah
Nominal Energy(kWh)	5.12
Nominal Power(kW)	2.56
Max Power(kW)	3.84
Charging Current(A)	50
Discharge Current(A)	50

Interface Definition

This section elaborates on interface functions of the front panel of the device.

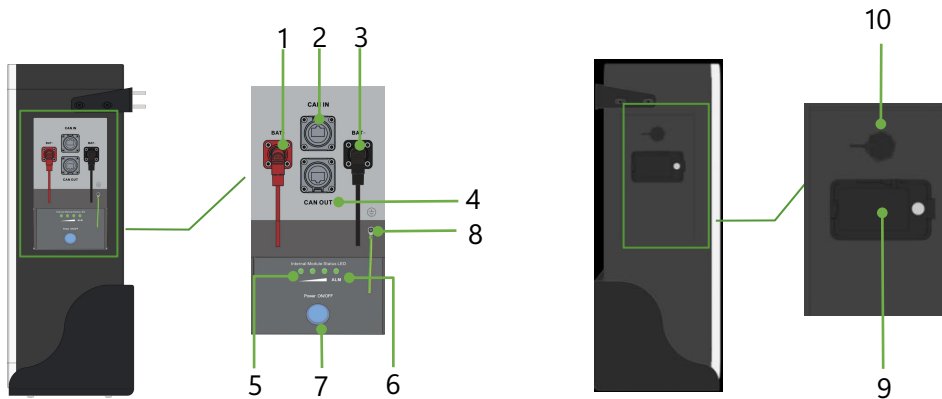

Figure 2-1 PowerDepot H5B the sketch of front interface.

Table 2-3 Interface Definition

Item	Name	Definition
1	Positive socket	The battery DC output positive pole, which is connected to the positive pole of the inverter through the cable When the system is used independently: The CAN/RS485 socket is connected to the inverter CAN/RS485 interface through the communication cable.
2	COM IN	When the system is used in parallel: This CAN/RS485 communication socket is connected to the COM OUT interface of the previous PowerDepot H5B through communication cable. (Factory default CAN communication mode)
3	Negative socket	The battery DC output negative pole, which is connected to the negative pole of the inverter through the cable When the system is used independently: This CAN/RS485 socket is a reservation interface When the system is used in parallel:
4	COM OUT	This CAN/RS485 communication socket is connected to the COM IN interface of the next PowerDepot H5B through a communication cable. (Factory default CAN communication mode)
5	SOC	The number of green lights on shows the remaining battery power,details in table2-4
6	ALM	Red light flashing when an alarm occurs, red light always on

Item	Name	Definition
		during protection status. After the condition of trigger protection is released, it can be automatically closed, details in table2-4
7	Reset switch	Press the switch and the battery system turn on. When the battery is in the non-use state such as storage, transportation etc., it needs to be turned off by pressing the Reset switch button, and the battery system will automatically sleep after the device without external load and power for 72 hours.
8	Ground connection point	Shell ground connection
9	DC circuit breaker	Circuit protection
10	COM	Communication cascade port, support RS232

Table 2-4 SOC/ALM Light instructions

Battery State	SOC	LED1	LED2	LED3	ALM
Shut down		Off	Off	Off	Off
	$66\% < SOC \leq 100\%$	On	On	On	On
Standby	$33\% < SOC \leq 66\%$	On	On	Off	On
	$20\% < SOC \leq 33\%$	On	Off	Off	On
	$10\% < SOC \leq 20\%$	Yellow light on	Off	Off	On
	$0\% \leq SOC \leq 10\%$	Red light on	Off	Off	On

Battery Management System(BMS)

Voltage Protection

Low Voltage Protection in Discharging:

When any battery cell voltage or total voltage is lower than the rated protection value during discharging, the over-discharging protection is activated, and the battery buzzer makes an alarm sound. Then battery system stops supplying power to the outside. When the voltage of each cell back to rated return range, the protection is over.

Over Voltage Protection in Charging:

During charging stage, the system will stop charging when the total voltage of the battery

pack is higher than rated value or the voltage of any single cell reaches the protection value. When total voltage or all cell back to rated range, the protection is over.

Current Protection

Over Current Protection in Charging:

When the charge current of each module $> 90A$, current limit protection mode is activated, current will be limited to $\leq 3A$, protection is removed after rated time delaying 10S.

Circulate like this until the current is lower than 90A.

Over Current Protection in Discharging:

When the discharge current is higher than 100A, the battery buzzer alarms and the system stops discharging after 15s. After protection, the discharging will restore in 60s delay or immediately when there is charging current.

Note:

The buzzer sound alarm setting can be turned off on the background software manually, and the factory default is on.

Temperature Protection

Low/Over temperature protection in charging:

When battery's temperature is beyond range of $0^{\circ}C \sim +65^{\circ}C$ during charging, temperature protection be activated, device stops charging. The protection is released when it back to rated range of working temperature.

Low/Over temperature protection in discharging:

When battery's temperature is beyond range of $-20^{\circ}C \sim +65^{\circ}C$ during discharging, temperature protection be activated, device stops supplying power to the outside. The protection is released when it back to rated range of working temperature.

Other Protection

Short Circuit Protection:

When the battery is activated from the off state, if a short circuit occurs, the DC circuit breaker will respond first. If the DC circuit breaker does not operate, the short circuit protection function of BMS will be activated automatically and cut off the device's output.

Self Shutdown:

When device have no connection of external loads, power supply and communication equipment for over 72 hours, the device will go into hibernation automatically.



CAUTION

The maximum operating current required for the electrical load shall be less than the maximum discharge current capacity of the battery.

3 Installation and Configuration

Preparations for installation

Safety Requirement

The product can only be installed by personnel who have been trained in the power-supply system and have sufficient knowledge of the electrical power system. The safety regulations and local safety regulations listed below should always be followed during the installation.

- All circuits connected to this power system with an external voltage of less than 48V must meet the SELV requirements defined in the IEC60950 standard.
- If operating within the power system cabinet, make sure the power system is not charged. Battery devices should also be switched off.
- Distribution cable wiring should be reasonable and has the protective measures to avoid touching these cables while operating power equipment.
- The following protective items must be worn when installing the battery system:



The isolation gloves



Safety goggles



Safety shoes

Figure 3-1 Safety Gear

Environmental requirements

Working temperature: $-20^{\circ}\text{C}\sim+55^{\circ}\text{C}$

Charging temperature range is $0^{\circ}\text{C}\sim+55^{\circ}\text{C}$,

Discharging temperature range is $-20^{\circ}\text{C}\sim+55^{\circ}\text{C}$

Storage temperature: $-10^{\circ}\text{C}\sim+35^{\circ}\text{C}$

Relative humidity: 5% ~ 85%RH

Elevation: no more than 4000m

Operating environment: Indoor or outdoor installation should avoid the sunlight and wind, no conductive dust and corrosive gas.

The following conditions shall be met:

- Installation location should be away from the sea to avoid corrosion from brine or high humidity environment.
- The ground for product arrangement shall be flat and level.

- Ensure there is no flammable explosive materials near to the installation places.
- The optimal ambient temperature is 15°C~30°C
- Keep away from dust and messy zones

Tools and data

Tools and meters that may be used for installation are shown in Figure 3-2.

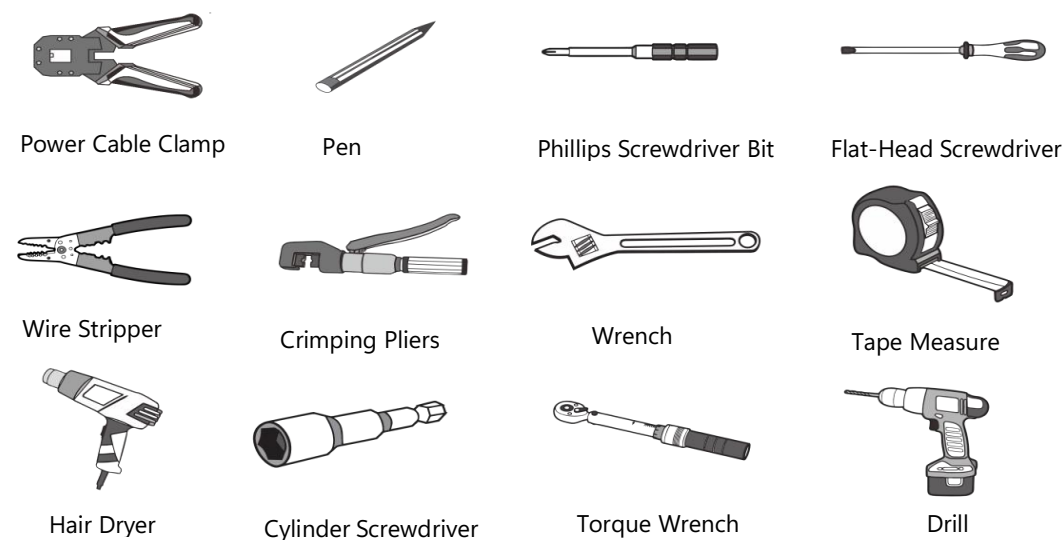

Figure 3-2 Tools

Technical preparation

Electrical interface check

Devices that can be connected directly to the battery can be user's equipment, power supplies, or other power supply equipment.

Confirm whether the user's equipment, the PV equipment or other power supply equipment has the DC output interface, and measure whether the output voltage of the interface meets the requirements of the voltage range of table 2-2

Verify the maximum discharge current capacity of the user's equipment, the PV equipment or other power supply equipment. The DC standby interface, and the maximum discharge current shall be higher than the maximum charging current of the products used in table 2-2.

If DC interface maximum discharge capacity of the user's equipment is less than the maximum charging current of products using in table 2-2, the user's interface should have the power equipment of DC current limiting function to ensuring the normal work of user equipment.

The security check

Firefighting equipment should be arranged near the equipment, such as portable dry powder fire extinguisher.

Automatic fire fighting system shall be provided for the case where necessary.

Flammable, explosive and other dangerous materials placed beside the battery are prohibited.







Unpacking inspection







When the equipment arrives at the installation site, loading and unloading should be carried out according to the rules and regulations, so as to prevent from being exposed to sunlight and rain.

Before unpacking, the total number of packages shall be indicated according to the shipping list attached to each package, and the case shall be checked for good condition. In the process of unpacking, handle with care and protect the surface coating of the object.

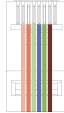
Open the package, the professional installation personnel should read the technical documents, verify the list, according to the configuration table and packing list, ensure objects are complete and intact. If the internal packaging is damaged, it must be inspected and recorded in detail.

Packing list is as follows:

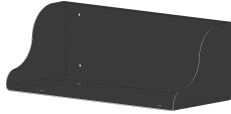
Item	Specification	Quantity	Figure
Battery	48V/100Ah	1	
Power cable- positive	Red /25mm ² /L2050mm	1	
Power cable- negative	Black /25mm ² /L2050mm	1	
Communication cable-to inverter	Black /L2000mm /Double RJ45 plug	1	
RJ45 Waterproof Connector	To pole of battery	2	
User Manual	User manual	1	

120ΩCAN resistor	120ΩCAN resistor	1	
Screw	screws M6	8	
Expansion screw	Expansion screw	8	
cardboard	Positioning cardboard	2	
Wrench	M3	1	
Battery bracket	Battery bracket	1	
Fixing bracket	Fixing bracket	1	

Engineering coordination

Attention should be paid to the following items before construction:

Power cable specification.

The power cable specification shall meet the requirements of maximum discharge current for each product.

Mounting space and bearing capacity.

Make sure that the battery has enough space to install, and that the battery rack and bracket have enough load capacity.

Wiring.

Make sure the power cable and ground wire are reasonable. Not easy to short-circuit, water and corrosion.

Equipment installation

The wall for battery installation shall be solid brick or cement wall with strong bearing capacity and wall thickness no less than 100mm.

Mounting space requirements:

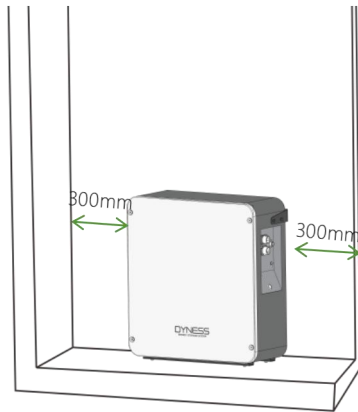

Floor installation

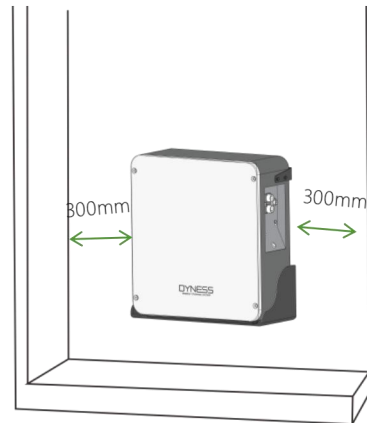

Wall installation

Table 3-1 Installation Steps

Step 1 System outage

Ensure that the battery is in a shutdown state (Disconnect the battery power cable and press the Reset button to turn it off).

Step 2 Mechanical installation

1. Bracket check
2. Equipment installation

Step 3 Electrical installation

1. Connect the grounding cable
2. Electrical installation
3. Connect inverter
4. Communication interface connection

Floor Installation

When the battery system is placed directly on the ground, a fixed support must be used to fix the top of the battery box on the wall.

1. Use the positioning cardboard (provided in accessory package) and mark the screw hole positions on the wall, as shown in the four holes on the left.
2. The bottom of board must be good connection with the ground level while marking the holes.

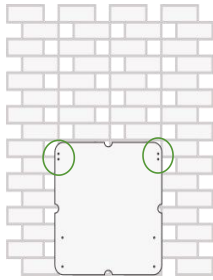

3. Press the marked position with the electric drill and trepanning 4 holes with a diameter of 10mm on the wall. The hole depth shall be greater than 70mm for fitting the expansion bolt of M6.

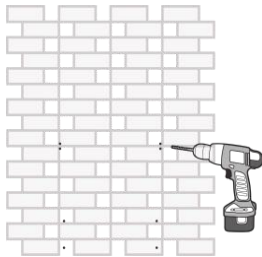

4. Fixing the expansion bolt M6 into the bottom of the hole on the wall.
5. Use the M6 bolt to fixing the Support bracket to the wall and control the torque at 6NM.



6. Carry the battery box to the installation site, and place it about 15mm away from the wall surface, fixing the Support bracket and the upper part of the battery box with M6 bolts.

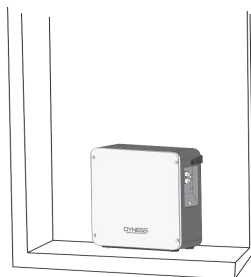

Mounted on the wall

The following accessories need to be added when install the powerbox Pro on the wall.

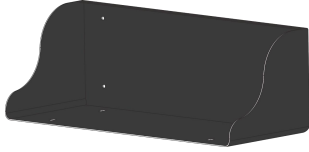

Battery Bottom Bracket ×1

Expansion Screw ×4

1. Use the positioning cardboard (provided in accessory package) and mark the screw hole positions on the wall, as shown in the four holes on the left.
2. The cardboard must be perpendicular to the ground while drawing the holes

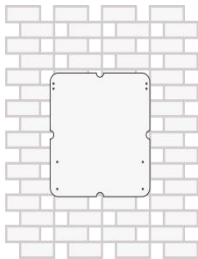

3. The bottom of the cardboard is about 300mm from the ground.
4. According to the position of the mark, 8 holes in diameter 10mm and depth of more than 70mm are hit on the wall with an electric drill, which are used for

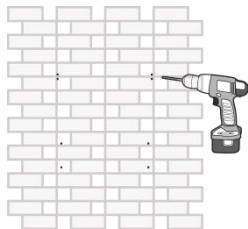

fitting expansion bolt M6.

5. Fixing the expansion bolt M6 into the bottom of the hole on the wall, and fix the Support bracket and Battery bottom bracket on the wall with M6 bolts, twisting force keeps 6NM.

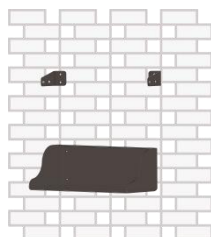

6. Carry or hoist the battery box to the installed Battery bottom bracket. Fixing the Support bracket and the upper part of the battery box with M6 bolts, twisting force keeps 6NM. Then fixing the Battery bottom bracket and the bottom part of the battery box with M6 bolts, twisting force keeps 6NM.



Electrical installation

Use multimeter to measure the device before power cable connection procedure. Check the cable continuity, confirm positive and negative and mark the cable labels.

Measuring methods:

Power cable check: select the buzzer mode of multimeter and detect the both ends of the same color cable. If the buzzer calls, it means the cable is in good condition.

After visual testing of power line connection, the positive and negative poles of the battery shall be connected respectively to the positive and negative poles of another device (inverter).

Connect the battery box to the ground cable

Customer needs to prepare a M6 OT terminals and ground cables. Connect the battery shell as shown below. The sectional area of the grounding cable shall be at least 6mm^2 and the bolt locking torque is 6NM.

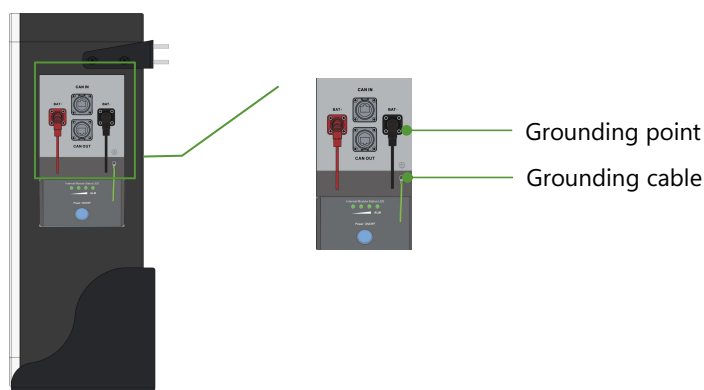

Inverter connection

Note:

If there is any question during installation, please contact retailer to avoid damage to the

equipment.

When the system is used independently:

Note: Before installation, please confirm whether the DIP switch mode of PowerDepot H5B is correct according to the the inverter model. For specific DIP operation methods, please refer to "3.2.4 Battery module DIP switch instruction and description." Except for the inverter specified by the customer's special requirements, the factory default DIP switch mode is DIP Switch mode 1 (ADD: 0010).

If the inverter is equipped with other DIP switch mode, open the cover and set DIP switch mode to the correct mode. Before opening the front panel to operate, you must inform us the ID of the PowerDepot H5B. We will record the battery ID and give device opening operation authorization. Except changing the DIP switch mode, no other operations can be done .

- The connection between inverter and battery should apply the power cable and communication cable which has been offered in your accessory package. (the communication cable is standardized type and The applicable inverter module has been indicated on the cable Label. Please contact us if the communication cable can not match yours inverter) The cable connection procedure showed below:
- Keep the battery system at power off state, connect the power cable to the interface on the input side of the inverter first, and then connect the power cable to the interface on the battery side.
- The battery output interface is a quick connector, and the power cable (positive, negative) plug can be directly inserted into the battery socket. The power cable cross section is 25 mm².

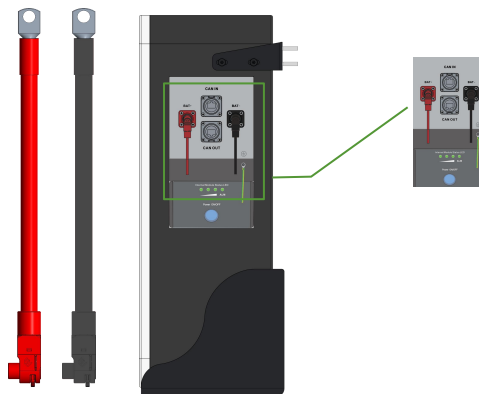

Communication interface connection、

Connect the CAN IN port of the battery to the CAN or RS485 communication interface of the inverter by a RJ45 communication cable.

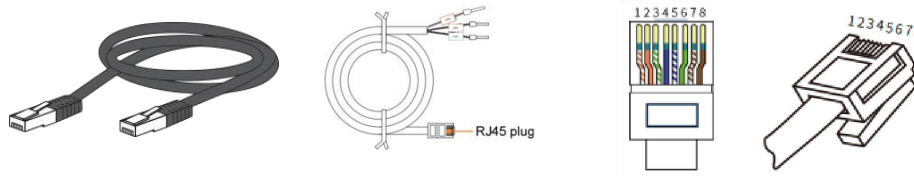
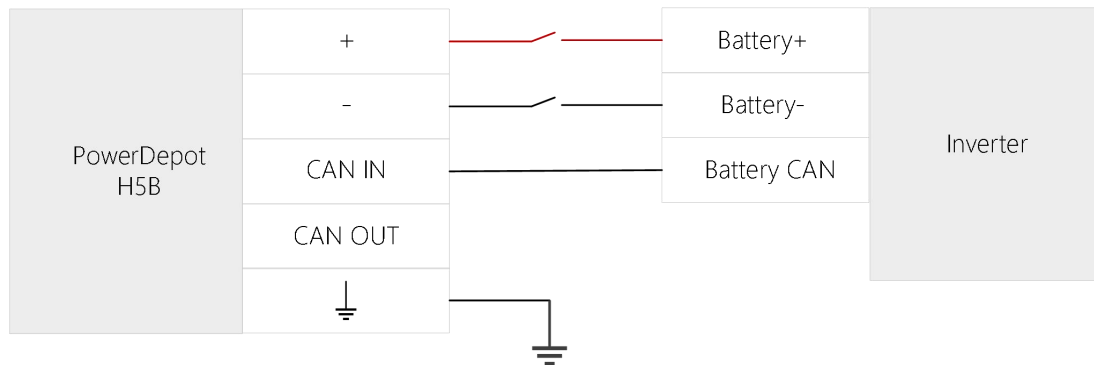
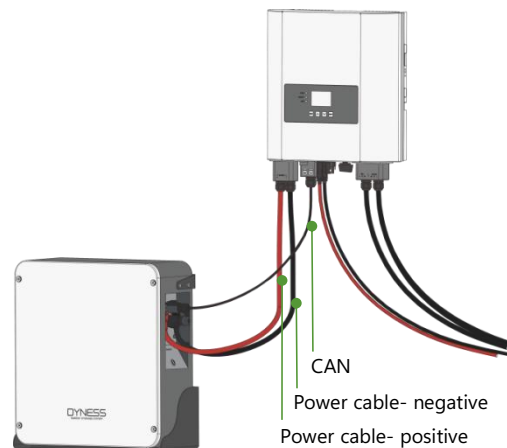

Table 3-2 Pin Definition

Foot position	Color	Definition
PIN1	Orange/white	485B
PIN2	Orange	485A
PIN3	Green/white	Reserve
PIN4	Blue	EXT CANH
PIN5	Blue/white	EXT CANL
PIN6	Green	Reserve
PIN7	Brown/white	INT CANH
PIN8	Brown	INT CANL



When the system used in parallel:



When the system is used in parallel, it supports up to 5 PowerDepot H5B in parallel.

According to the number of parallel system (Take three PowerDepot H5B in parallel as an example), the system needs to use: Power cable × 3pair, Battery-Inverter communication cable × 1PCS, Battery-Battery communication cable × 2PCS, Distribution box × 1PCS. The over-current capacity of the distribution box should be much higher than the maximum nominal current value when the load is running.

PINOUT of system parallel communication cable:

PINOUT of Battery-Battery communication cable diagram shown as below:

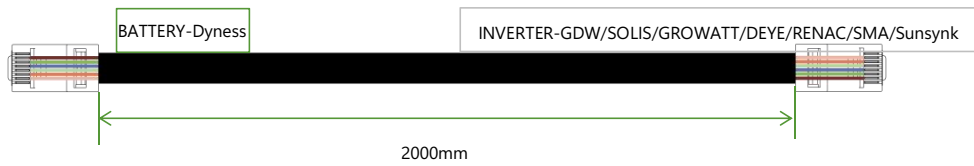

BATTERY-Dyness

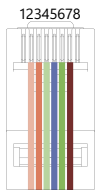

PIN	Color	Definition
1	Orange/White	485_B
2	Orange	485_A
3	Green/White	NC
4	Blue	EXT CANH
5	Blue/White	EXT CANL
6	Green	NC
7	Brown/White	INT CANH
8	Brown	INT CANL

INVERTER-GDW/SOLIS/GROWATT/DEYE/RENAC/SMA/Sunsynk

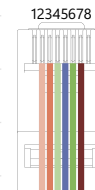

PIN	Color	Definition
1	Orange/White	485_B
2	Orange	485_A
3	Green/White	NC
4	Blue	EXT CANH
5	Blue/White	EXT CANL
6	Green	NC
7	Brown/White	NC
8	Brown	NC



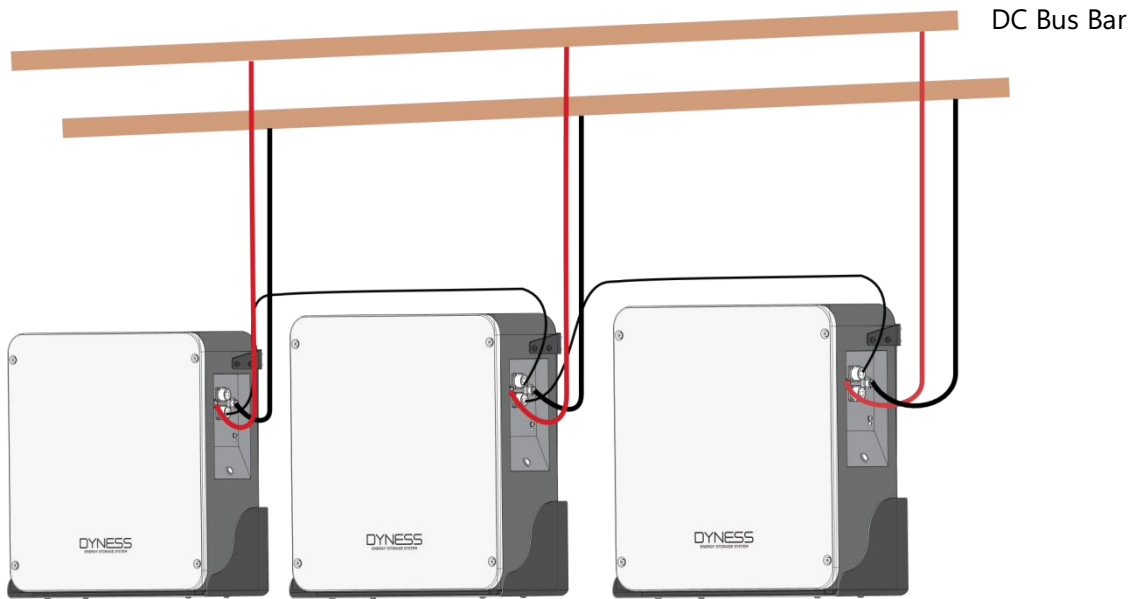

Battery module DIP switch definition and description

Table 3-3 DIP switch Definition

DIP switch position (master communication protocol and baud rate selection)

#1	#2	#3	#4
			Baud rate selection
Define different protocols; Distinguish between master and slave			OFF: CAN: 500K,485: 9600 ON: CAN: 250K,485: 115200

DIP switch description:

When the batteries are connected in parallel, the host communicates with the slaves through the CAN interface. The host summarizes the information of the entire battery system and communicates with the inverter through CAN or 485.

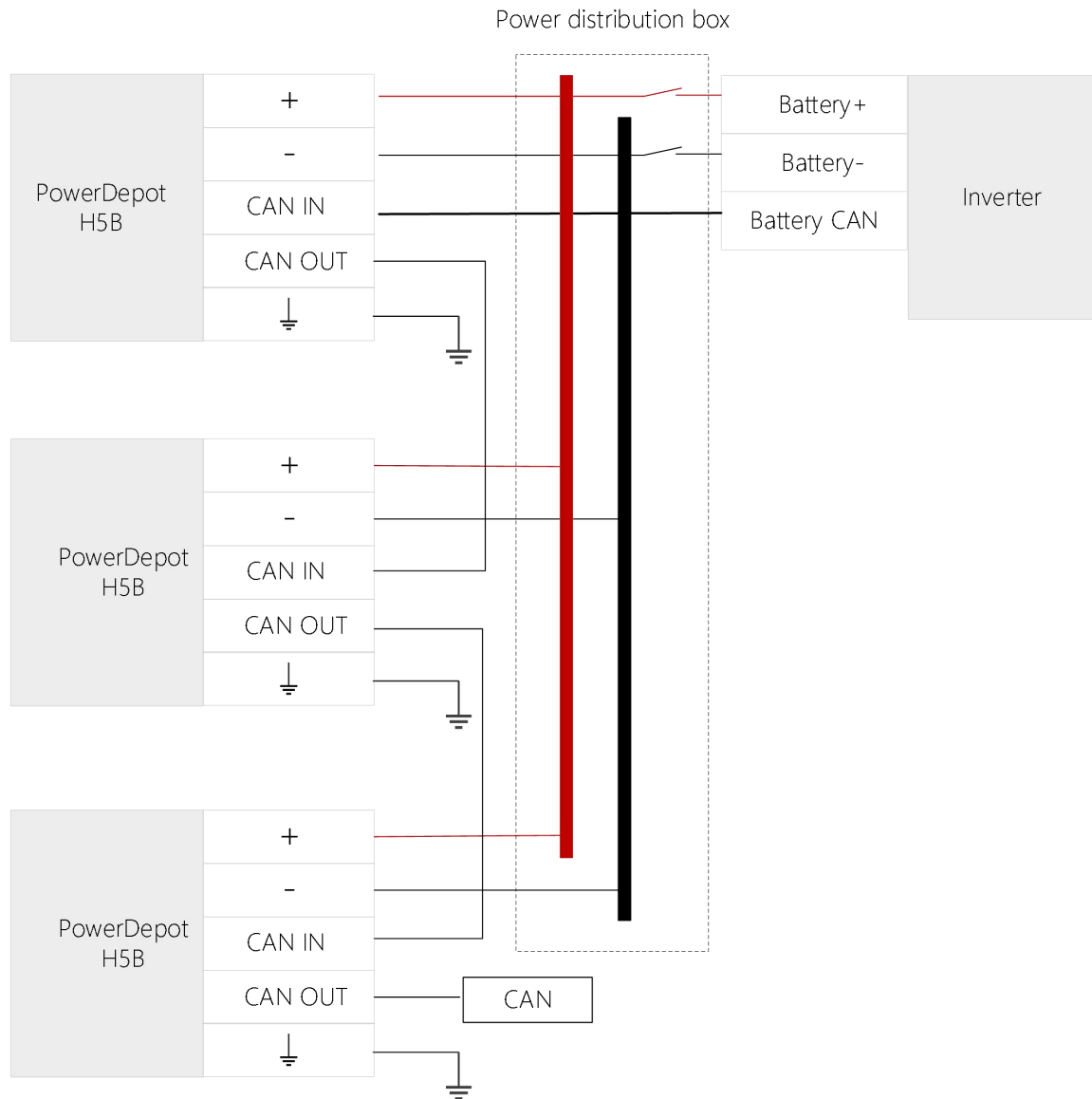

For different inverter model,you need to set different DIP mode:

1. Ensure the communication cable that communicates with the inverter is correct.
2. When the battery works with GOODWE, Solis, LUX, Sofar, DEYE(SUNSYNK), VICTRON, IMEON, Sungrow,SMA,RENAC,DELIOS,SAJ(CAN Comm) inverters,before starting the battery,you need to put the master DIP switch "# 3" to the "ON" position (to the top), then turn on the batteries.

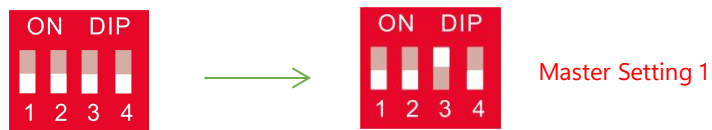

For different inverter model,you need to set different DIP mode:

3. If the battery communicate with the Axpert-king/VMIII/MAX,Infinisolar,Growatt SPH(CAN comm), GMDE, change the master module DIP switch to 0100("#2" to "ON") before connecting.



4. If the battery communicates with the Growatt SPF HVM-P/ES/WPV by RS485 communication, change the master module DIP switch to 0110("#2" & "#3" to "ON") before connecting.



5. If the battery communicates with the Schneider Conext Series, turn the master DIP switch "#1" and "#3" to "ON".



6. When you setup the master DIP as setting 1~4, all the slaves keep the DIP 0000, no need to change.

7. If the energy storage system has only one powerdepot, it is the master itself, and still follow the above steps.

Note: For more information of matching inverter brands, please subject to the latest document

<The list of compatibility between Dyness ESS and Inverters >.

Proceed as follows:

- Remove the four screws on the cover and open the cover.
- Find the red DIP switch on the module and confirm the status of the DIP switch.
- Set the DIP switch to the correct state
- Re-install the cover with four screws which were removed in step a.

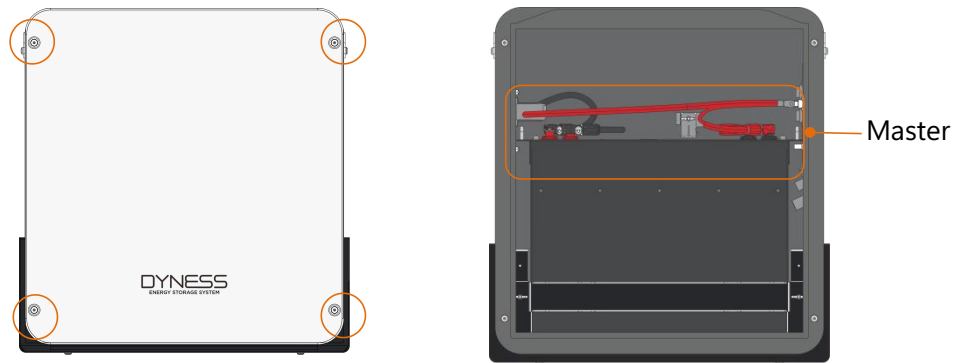

(a)

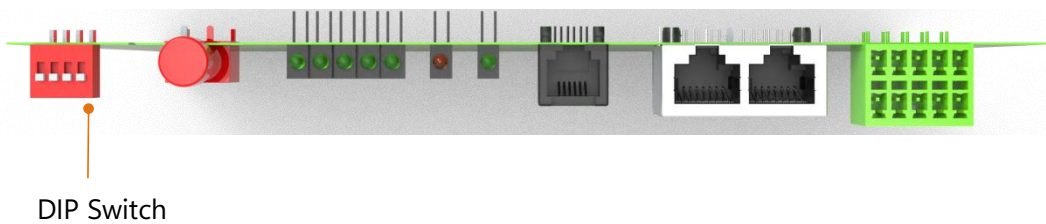

DIP Switch

(b)

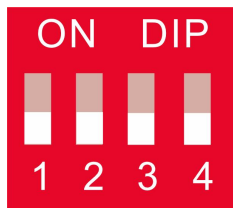

(c)

CAUTION

- Confirm the positive and negative interface of battery output terminal and inverter input terminal. The red power cable is for connection of the battery's positive to inverter's positive, and the black power cable is for the connection of battery's negative to inverter's negative. Before connection, it is necessary to confirm the charge and discharge parameters of the inverter interface.
 - Voltage and current should meet the requirements of Table 2-2 battery performance parameters.
 - When you use battery in parallel, it doesn't need to change the DIP switch of the host module in the master PowerDepot H5B which communicates with the inverter directly.
- How to judge that the communication between PowerDepot H5B and PowerDepot H5B is normal:
1. If there is communication between the inverter and battery system, it can be judged by

the maximum charge and discharge current value on the inverter sent by the battery.

(The maximum charge and discharge current value displed on the inverter)/(The maximum charge and discharge current value of one battery module)=number of modules

If the equation holds after calculation, it means communication between PowerDepot H5B and PowerDepot H5B is normal.

2. If the PowerDepot H5B ALM light board shows three different colors flash alternately, it means the communication between PowerDepot H5B is fault.

Table 3-4 Battery& Inverter power matching table

Power of Hybrid Inverter/ Off-grid Inverter	PowerDepot H5B Type	System Energy(kWh)
2KW	PowerDepot H5B	5.12
3KW	PowerDepot H5B	5.12
4KW	2*PowerDepot H5B	10.24
5KW	2*PowerDepot H5B	10.24
6KW	2*PowerDepot H5B	10.24
8KW	3*PowerDepot H5B	15.36

Equipment Use	Charging	The battery's long-term continuous charging current should be $\leq 0.5C$ If the battery remaining capacity is empty, please charge it within 48 hours after the battery is empty.
	Discharging	The long-term continuous discharge current of the battery should be $\leq 0.5C$ The recommend maximum depth of discharge (DOD)of Battery PACK is no more than 85%.

Battery parameter settings on the inverter

Max Charging(Bulk) Voltage: 56.5V

Absorption Voltage: 56V

Float Voltage: 55.5V

Shut Down(cut off) Voltage: 48~50V

Shut Down(cut off) SOC: 20%

Restart Voltage: 52V

Max Charge Current:50A*battery QTY

Max Discharge Current: 50A*battery QTY

Capacity: 100Ah

Register on the website after installation

After the battery system installation is completed and the running is normal, you need to log in to the DYNESS official website to register the product installation and use information to make the product warranty effective. Please follow the instructions on the website to register.

<http://www.dyness-tech.com/>  Service  Sign Up

4 Use, maintenance and troubleshooting

Battery system usage and operation instructions

After completing the electrical installation, follow steps below to start the battery system.

.Check whether the breaker is in OFF state.

.Press the battery power button, the power button LED light is on, and LED indicator lights will be on and show the green color after self-check. After pressing the power button, if the battery status indicator lights shows abnormally, please refer to the "4.2 Alarm description and processing". If the failure cannot be eliminated, please contact the retailer timely.

.Use a voltmeter to measure whether the voltage across the BAT + / BAT- terminals of the inverter is higher than 44.8V, and check whether the voltage polarity is consistent with the input polarity of the inverter. If the voltage across the terminals BAT + / BAT- of the inverter is higher than 44.8V, which means the battery has begun to work normally.

.After confirm the battery output voltage and polarity are correct, turn on the inverter, then turn on the circuit breaker switch.

.Check whether the indicator light for the inverter and the battery connection (the communication indicator and the battery access status indicator) is in normal condition. If normal, the connection between the battery and the inverter is completed. If the indicator light show abnormal, please check the inverter manual or contact the local retailer.

Alarm description and processing

When protection mode is activated or system failure occurred, the ALM indicator on the front panel will alarm. User can inspect the system through management software to check specific alarm class and take appropriate action.

Alarm and countermeasure for affecting system output

If there are any abnormalities affecting the output, such as battery cell in the battery module occurs over-current protection during charge/discharge, under-voltage protection, and temperature protection in the system, please refer to Table 4-1.

Table 4-1 Main alarm and Protection

Statue	Alarm category	Alarm indication	Processing
Discharge state	Over-current	RED light	Stop discharge and reduce discharge current below rated value.
		Buzzer start	
Discharge state	High temp protection	RED light	Stop discharging and find out the cause of the trouble.
		always on	

Under voltage protect	RED light always on Buzzer start	Start charging.
SOC less than 10%	LED1 RED light on	Start charging.

Alarm and countermeasure for un-affecting system output

If a low SOC alarm occurs, the battery system also issues a corresponding alarm signal. Maintainer should check the equipment according to the prompt information, determine the type and position of the fault, and take corresponding countermeasures to avoid affecting the system output. The countermeasures refer to Table 4-2.

Table 4-2 minor alarm

Alert category	Alarm indication	Countermeasure
$0% < SOC \leq 10%$	System working status: LED1 red light is always on	Stop discharging, and charge the battery system in time.

Analysis and treatment of common faults

Table 4-3 Analysis and treatment of common faults

Item	Fault phenomenon	Reason analysis	Solution
1	The indicator does not respond after the system power on	Make sure press and hold the power button for 3s.	Check the power switch
2	No DC output after the system power on	Check if the DC breaker is turned on	Check the status of the DC circuit breaker on the side of cabinet
3	No DC output and red light flashing, buzzer beeping	Battery voltage is too low	Charging the battery system
4	The battery cannot be fully charged	Charge voltage is low	Adjust charging voltage within 57V~57.6V range
5	The power cable sparks when system power on and ALM indicated Red light on	Power connection short-circuit	Turn off the battery, check the cause of the short circuit

6	ALM LED flash alternately without stopping	Modules communication address distribution is faulty	Check the external communication cable connection firstly. Check the slave PowerDepot H5B DIP setting.
---	--	--	---

If you have any technical help or question, please contact the retailer in time.



DISCOVER YOUR NATURE

Address: No. 511 Chenzhuang West Road, Sanshui Street,
Jiangyan District, Taizhou City

Email: service@dyness.com

Tel: +86 400 666 0655

Web: www.dyness.com



Official Website



Digital version access